

## FEATURES

- **Step-Up/Direct-Connect Fractional Charge Pump Provides Up to 92% Efficiency**
- **Up to 400mA Continuous Output Current**
- **Independent Current and Dimming Control for 1-6 LED MAIN, 1-4 LED SUB and RGB LED Displays**
- **LED Currents Programmable Using 2-Wire I<sup>2</sup>C™ Serial Interface**
- **1% LED Current Matching**
- **Low Noise Constant Frequency Operation\***
- **Minimal Component Count**
- **Automatic Soft-Start Limits Inrush Current**
- **16 Exponentially Spaced Dimming States Provides 128:1 Brightness Range for MAIN and SUB Displays**
- **Up to 4096 Color Combinations for RGB Display**
- **Low Operating Current: I<sub>VIN</sub> = 180μA**
- **Tiny, Low Profile 24-Lead (4mm × 4mm × 0.75mm) QFN Package**

## APPLICATIONS

- Cellular Phones
- Wireless PDAs
- Multidisplay Handheld Devices

LT, LTC and LT are registered trademarks of Linear Technology Corporation.

I<sup>2</sup>C is a trademark of Philips Electronics N.V.

\* U.S. Patent 6,411,531

## DESCRIPTION

The LTC<sup>®</sup>3206 is a highly integrated multidisplay LED controller. The part contains a high efficiency, low noise fractional step-up/direct-connect charge pump to provide power for both main and sub white LED displays plus an RGB color LED display. The LTC3206 requires only four small ceramic capacitors plus two resistors to form a complete 3-display LED power supply and current controller.

Maximum currents for the main/sub displays and RGB display are set independently. Current for each LED is controlled with an internal current source. Dimming and ON/OFF control for all displays is achieved via a 2-wire serial interface. Two auxiliary LED pins can be individually assigned to either the MAIN or SUB displays. 16 individual dimming states exist for both the MAIN and SUB displays. Each of the RED, GREEN and BLUE LEDs have 16 dimming states as well, resulting in up to 4096 color combinations.

The LTC3206 charge pump optimizes efficiency based on V<sub>IN</sub> and LED forward voltage conditions. The part powers up in direct-connect mode and automatically switches to 1.5x step-up mode once any enabled LED current source begins to enter dropout. Internal circuitry prevents inrush current and excess input noise during start-up and mode switching. The LTC3206 is available in a 24-lead (4mm × 4mm) QFN package.

## TYPICAL APPLICATION

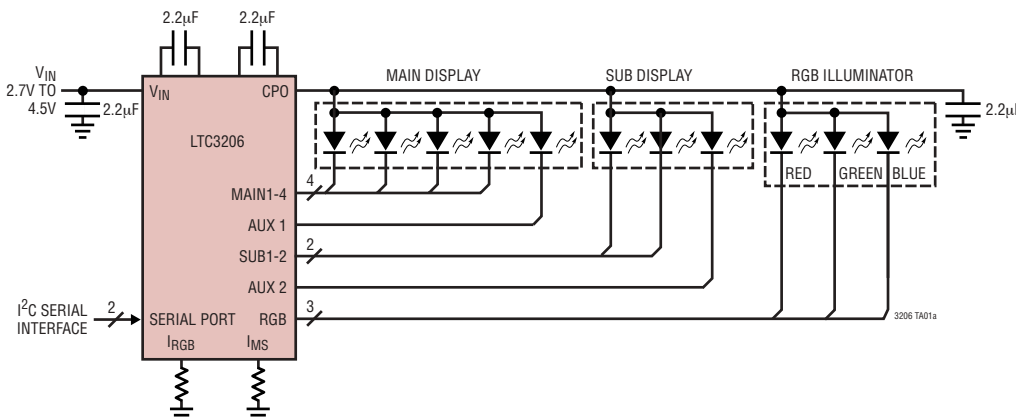

**5-LED Main Display Efficiency vs Input Voltage**

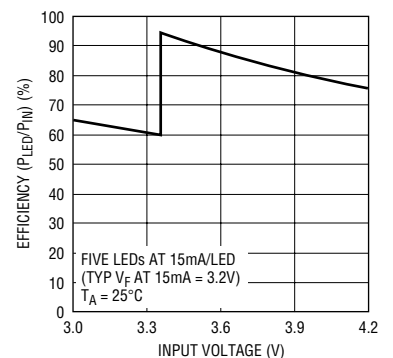

3206 TA01b

3206f

## ABSOLUTE MAXIMUM RATINGS

(Note 1)

$V_{IN}$ , $DV_{CC}$ , CPO to GND .....	-0.3V to 6V
SDA, SCL, ENRGB/S .....	-0.3V to ( $DV_{CC} + 0.3V$ )
$I_{CPO}$ (Continuous) (Note 4) .....	400mA
(Pulsed at 10% Duty Cycle) (Note 4) .....	1A
$I_{MAIN1-4}$ , $I_{SUB1,2}$ , $I_{AUX1,2}$ (Note 4) .....	100mA
(Pulsed at 10% Duty Cycle) (Note 4) .....	125mA
$I_{RED, GREEN, BLUE}$ (Note 4) .....	100mA
(Pulsed at 10% Duty Cycle) (Note 4) .....	125mA
$I_{MS}$ , $I_{RGB}$ (Note 4) .....	1mA
CPO Short-Circuit Duration .....	Indefinite
Operating Temperature Range (Note 2) ..	-40°C to 85°C
Storage Temperature Range .....	-65°C to 125°C

## PACKAGE/ORDER INFORMATION

<p>TOP VIEW</p> <p>24-LEAD (4mm x 4mm) PLASTIC QFN</p> <p><math>T_{JMAX} = 125^{\circ}C</math>, <math>\theta_{JA} = 37^{\circ}C/W</math>, <math>\theta_{JC} = 2^{\circ}C/W</math></p> <p>EXPOSED PAD IS PGND (PIN 25)</p> <p>MUST BE SOLDERED TO PCB</p>	ORDER PART NUMBER
	LTC3206EUF
	UF PART MARKING
	3206

Consult LTC Marketing for parts specified with wider operating temperature ranges.

## ELECTRICAL CHARACTERISTICS

The ● denotes the specifications which apply over the full operating temperature range, otherwise specifications are at  $T_A = 25^{\circ}C$ .  $V_{IN} = 3.6V$ ,  $DV_{CC} = 3V$  unless otherwise noted.

SYMBOL	PARAMETER	CONDITIONS	MIN	TYP	MAX	UNITS
<b>Input Power Supply</b>						
	$V_{IN}$ Operating Voltage		● 2.7		4.5	V
	$DV_{CC}$ Operating Voltage		● 1.5		5.5	V
	$V_{IN}$ Operating Current	$I_{CPO} = I_{MS} = I_{RGB} = 0\mu A$ , Direct-Connect Mode $I_{CPO} = I_{MS} = I_{RGB} = 0\mu A$ , 1.5x Step-Up Mode		180 3.9		$\mu A$ mA
	$DV_{CC}$ Operating Current	Serial Port Idle			1	$\mu A$
	$V_{IN}$ Shutdown Current			7.3	10	$\mu A$
	$DV_{CC}$ Shutdown Current				1	$\mu A$
<b>White LED Current (MAIN1-MAIN4, SUB1, SUB2, AUX1, AUX2)</b>						
	$I_{MS}$ Servo Voltage	$25\mu A < I_{MS} < 75\mu A$	● 0.585 0.582	0.6 0.6	0.615 0.618	V V
	Full-Scale LED Current Ratio ( $I_{LED}/I_{MS}$ )	MAIN1-MAIN4, SUB1, SUB2, AUX1, AUX2, Voltage = 1V	● 368	400	432	mA/mA
	LED Dropout Voltage	1.5x Mode Switch Threshold, $I_{LED} = 20mA$		80		mV
	LED Brightness Range		0.78		100	%
	LED Current Matching	MAIN-MAIN, MAIN-AUX, SUB-SUB, SUB-AUX		1		%
<b>RGB LED Current (RED, GREEN, BLUE)</b>						
	$I_{RGB}$ Servo Voltage	$25\mu A < I_{RGB} < 75\mu A$	● 0.585 0.582	0.6 0.6	0.615 0.618	V V
	LED Current Ratio ( $I_{LED}/I_{RGB}$ )	RED, GREEN, BLUE Voltage = 1V	360	400	440	mA/mA
	RGB LED Dropout Voltage	1.5x Mode Switch Threshold, $I_{LED} = 20mA$		80		mV
	RGB PWM (Duty Factor) Range		0/15		15/15	%
<b>Charge Pump (CPO)</b>						
	1x Mode Output Impedance			0.68		$\Omega$
	1.5x Mode Output Impedance	$V_{IN} = 3V$ , $V_{CPO} = 4.2V$ (Note 3)		1.90		$\Omega$

## ELECTRICAL CHARACTERISTICS

The ● denotes the specifications which apply over the full operating temperature range, otherwise specifications are at  $T_A = 25^\circ\text{C}$ .  $V_{IN} = 3.6\text{V}$ ,  $DV_{CC} = 3\text{V}$  unless otherwise noted.

SYMBOL	PARAMETER	CONDITIONS	MIN	TYP	MAX	UNITS
	CPO Regulation Voltage	$I_{CPO} = 20\text{mA}$ , 1.5x Mode		4.75		V
	CLK Frequency		0.68	0.96	1.36	MHz

### SDA, SCL, ENRGB/S

$V_{IL}$	Low Level Input Voltage		●		$0.3 \cdot DV_{CC}$	V
$V_{IH}$	High Level Input Voltage		●	$0.7 \cdot DV_{CC}$		V
$I_{IH}$	Input Current	SDA, SCL, ENRGB/S = $DV_{CC}$		-1	1	$\mu\text{A}$
$I_{IL}$	Input Current	SDA, SCL, ENRGB/S = 0V		-1	1	$\mu\text{A}$
$V_{OL}$	Digital Output Low (SDA)	$I_{PULLUP} = 3\text{mA}$	●		0.4	V

### Timing Characteristics (Note 5)

$t_{SCL}$	Clock Operating Frequency				400	kHz
$t_{BUF}$	Bus Free Time Between Stop and Start Condition			1.3		$\mu\text{s}$
$t_{HD, STA}$	Hold Time After (Repeated) Start Condition			0.6		$\mu\text{s}$
$t_{SU, STA}$	Repeated Start Condition Setup Time			0.6		$\mu\text{s}$
$t_{SU, STD}$	Stop Condition Setup Time			0.6		$\mu\text{s}$
$t_{HD, DAT(OUT)}$	Data Hold Time			225	900	ns
$t_{HD, DAT(IN)}$	Input Data Hold Time			0	900	ns
$t_{SU, DAT}$	Data Setup Time			100		ns
$t_{LOW}$	Clock Low Period			1.3		$\mu\text{s}$
$t_{HIGH}$	Clock High Period			0.6		$\mu\text{s}$
$t_f$	Clock Data Fall Time			20	300	ns
$t_r$	Clock Data Rise Time			20	300	ns
$t_{SP}$	Spike Suppression Time			50		ns

**Note 1:** Absolute Maximum Ratings are those values beyond which the life of a device may be impaired.

**Note 2:** The LTC3206E is guaranteed to meet performance specifications from  $0^\circ\text{C}$  to  $70^\circ\text{C}$ . Specifications over the  $-40^\circ\text{C}$  to  $85^\circ\text{C}$  operating temperature range are assured by design, characterization and correlation

with statistical process controls.

**Note 3:** 1.5x mode output impedance is defined as  $(1.5V_{IN} - V_{CPO})/I_{OUT}$ .

**Note 4:** Based on long term current density limitations.

**Note 5:** All values are referenced to  $V_{IH}$  and  $V_{IL}$  levels.

## TYPICAL PERFORMANCE CHARACTERISTICS

LED Pin Sink Current vs LED Pin Voltage

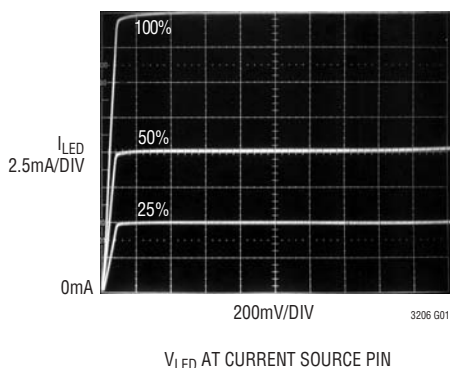

Input and Output Charge Pump Noise

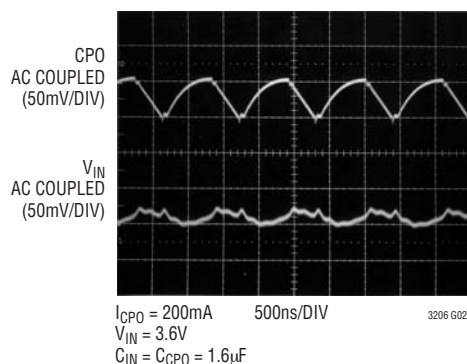

LED Pin Dropout Voltage vs LED Pin Current

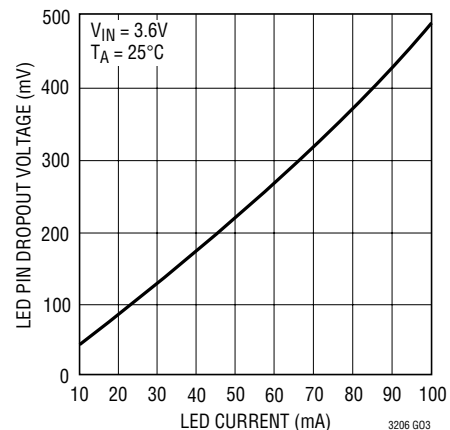

# TYPICAL PERFORMANCE CHARACTERISTICS

**1x Mode Switch Resistance vs Temperature**

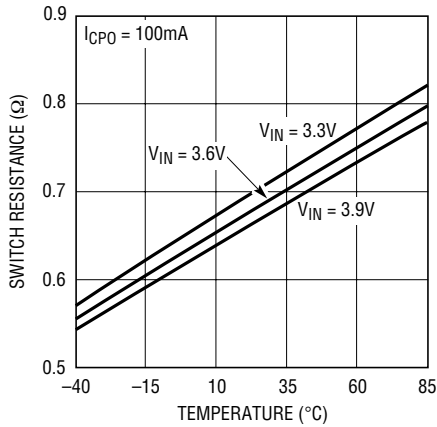

**1.5x Mode Charge Pump Open-Loop Output Resistance vs Temperature ( $1.5V_{IN} - V_{CPO}$ )/ $I_{CPO}$**

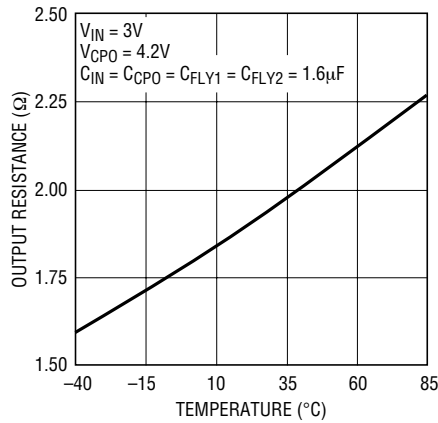

**1.5x Mode CPO Voltage vs Load Current**

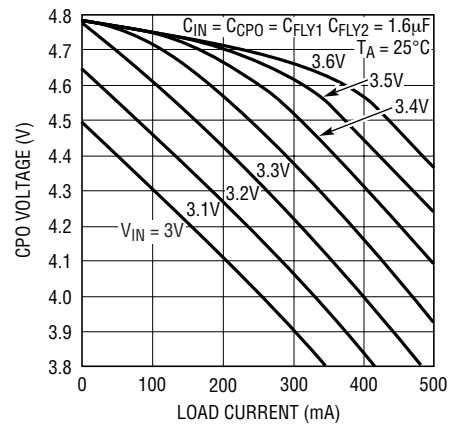

**Oscillator Frequency vs Supply Voltage**

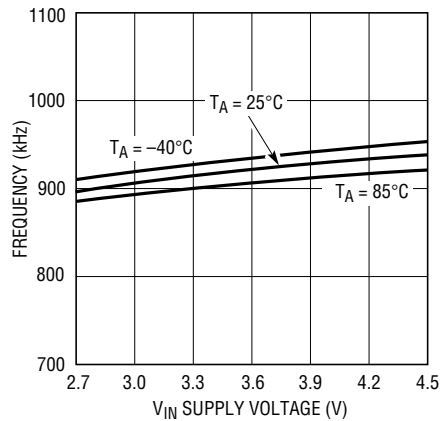

**DV<sub>CC</sub> Shutdown Current vs Input Voltage**

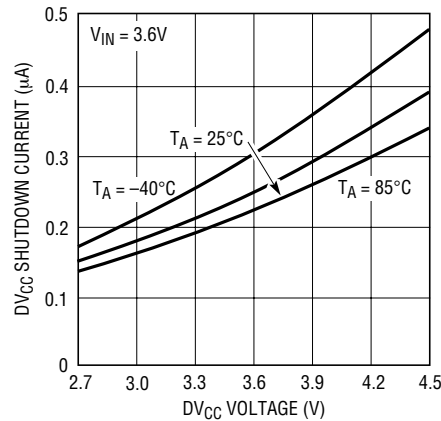

**V<sub>IN</sub> Shutdown Current vs Input Voltage**

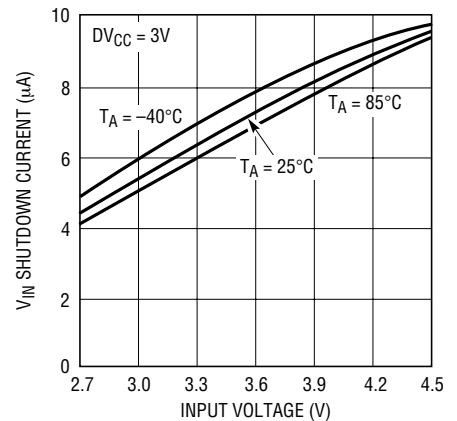

**1x Mode No Load Supply Current vs Input Voltage**

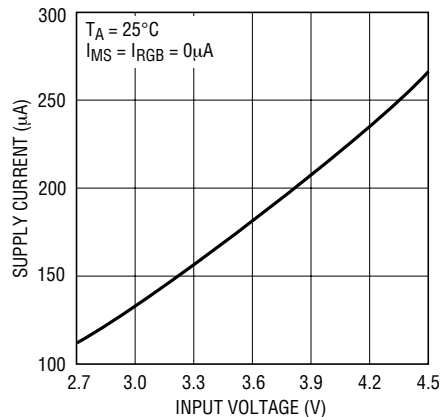

**1.5x Mode Supply Current vs I<sub>CPO</sub> ( $I_{IN} - 1.5I_{CPO}$ )**

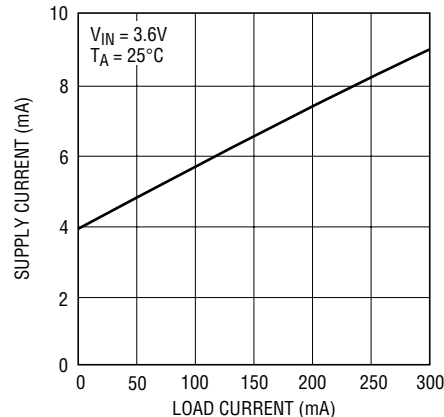

**LED Pin Voltage for Higher LED Currents**

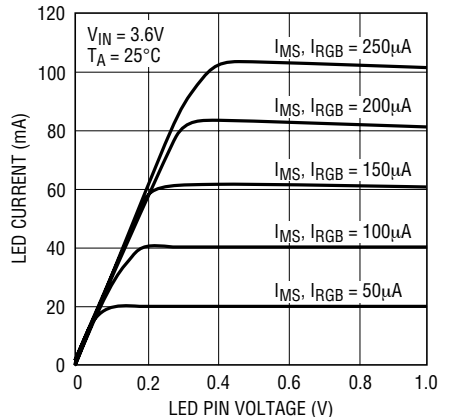

## PIN FUNCTIONS

**SUB1, SUB2 (Pins 1, 2):** Current Source Outputs for the SUB Display White LEDs. The current for the SUB display is controlled by the resistor on the  $I_{MS}$  pin. The LEDs on the SUB display can be set to exponentially increasing brightness levels from 0.78% to 100% of full-scale. See Table 1.

**C1<sup>+</sup>, C1<sup>-</sup>, C2<sup>+</sup>, C2<sup>-</sup> (Pins 5, 4, 6, 3):** Charge Pump Flying Capacitor Pins. A 2.2 $\mu$ F X7R or X5R ceramic capacitor should be connected from C1<sup>+</sup> to C1<sup>-</sup> and another from C2<sup>+</sup> to C2<sup>-</sup>.

**DV<sub>CC</sub> (Pin 7):** This pin sets the logic reference level of the SDA, SCL and ENRGB/S pins.

**SDA (Pin 8):** Input Data for the I<sup>2</sup>C Serial Port. Serial data is shifted in one bit per clock to control the LTC3206 (see Figures 3 and 4). The logic level for SDA is referenced to DV<sub>CC</sub>.

**SCL (Pin 9):** Clock Input for the I<sup>2</sup>C Serial Port (see Figures 3 and 4). The logic level for SCL is referenced to DV<sub>CC</sub>.

**ENRGB/S (Pin 10):** This pin is used to enable and disable either the RED, GREEN and BLUE current sources or the SUB display depending on which is programmed to respond via the I<sup>2</sup>C port. Once ENRGB/S is brought high, the LTC3206 illuminates the RGB or SUB display with the color combination or intensity that was previously programmed via the I<sup>2</sup>C port. The logic level for ENRGB/S is referenced to DV<sub>CC</sub>.

**I<sub>MS</sub> (Pin 11):** This pin controls the maximum amount of LED current in both the MAIN and SUB LED displays. The  $I_{MS}$  pin servos to 0.6V when there is a resistor to ground. The full scale (100%) currents in the MAIN and SUB display LEDs will be 400 times the current at the  $I_{MS}$  pin.

**I<sub>RGB</sub> (Pin 12):** This pin controls the amount of LED current at the RED, GREEN and BLUE LED pins. The  $I_{RGB}$  pin servos to 0.6V when there is a resistor to ground. The current in the RED, GREEN and BLUE LEDs will be 400 times the current at the  $I_{RGB}$  pin when programmed to full scale.

**SGND (Pin 13):** Ground for the control logic. This pin should be connected directly to a low impedance ground plane.

**CPO (Pin 14):** Output of the Charge Pump. This output should be used to power white, blue and “true” green LEDs. Red LEDs can be powered from  $V_{IN}$  or CPO. An X5R or X7R low impedance (ceramic) 2.2 $\mu$ F charge storage capacitor is required on CPO.

**V<sub>IN</sub> (Pin 15):** Supply Voltage for the Charge Pump. The  $V_{IN}$  pin should be connected directly to the battery and bypassed with a 2.2 $\mu$ F X5R or X7R ceramic capacitor.

**RED, GREEN, BLUE (Pins 16, 17, 18):** Current Source Outputs for the RGB Illuminator LEDs. The currents for the RGB LEDs are controlled by the resistor on the  $I_{RGB}$  pin. The RGB LEDs can independently be set to any duty cycle from 0/15 through 15/15 under software control giving a total of 16 shades per LED and 4096 colors for the illuminator. See Table 1. The RGB LEDs are modulated at 1/240 the speed of the charge pump oscillator (approximately 4kHz).

**MAIN1-MAIN4 (Pins 22, 21, 20, 19):** Current Source Outputs for the Main Display White LEDs. The current for the main display is controlled by the resistor on the  $I_{MS}$  pin. The LEDs on the MAIN display can be set to 16 exponentially increasing brightness steps from 0.78% to 100% of full scale. See Table 1.

**AUX1, AUX2 (Pins 23, 24):** Current source outputs for the auxiliary white LEDs. The auxiliary current sources can be individually assigned to be either MAIN display or SUB display LEDs via the I<sup>2</sup>C serial port. When either AUX1 and/or AUX2 are assigned to the MAIN display they will have the same power setting as the other MAIN LEDs. Likewise, when either AUX1 and/or AUX2 are assigned to the SUB display they will have the same power setting as the other SUB LEDs. The currents for the AUX1 and AUX2 pins are controlled by the resistor on the  $I_{MS}$  pin.

**PGND (Pin 25, Exposed Pad):** Power Ground for the Charge Pump. This pin should be connected directly to a low impedance ground plane.

# BLOCK DIAGRAM

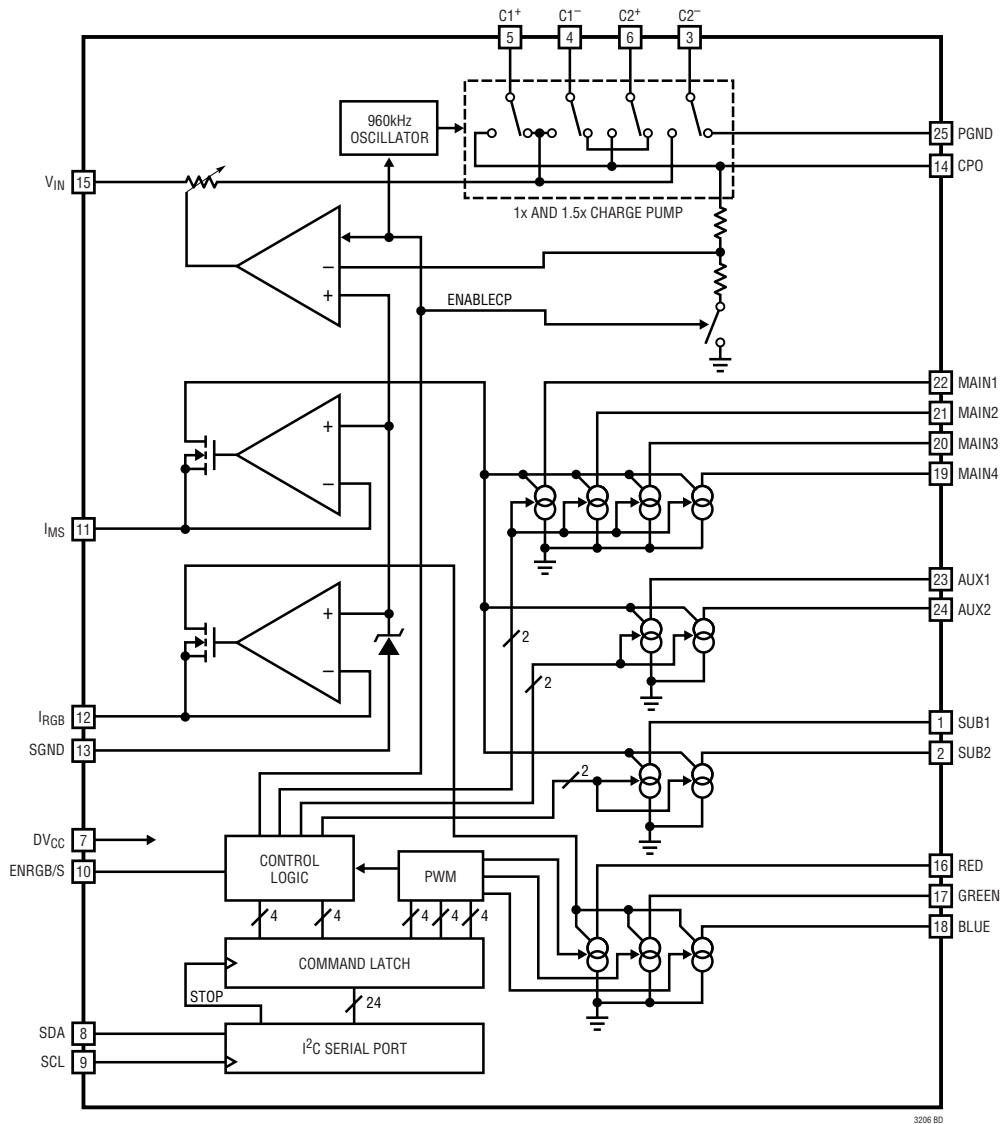

## OPERATION

### Power Management

To optimize efficiency, the power management section of the LTC3206 provides two methods of supplying power to the CPO pin: 1x direct connect mode or 1.5x boost mode. When any display of the LTC3206 is enabled, the power management system connects the CPO pin directly to  $V_{IN}$  with a low impedance switch. If the voltage supplied at  $V_{IN}$  is high enough to power all of the LEDs with the programmed current, the system will remain in this “direct connect” mode providing maximum efficiency. Internal

circuits monitor all current sources for the onset of “drop-out,” the point at which the current sources can no longer supply programmed current. As the battery voltage falls, the LED with the largest forward voltage will reach the drop-out threshold first. When any of the LED pins reach the drop-out threshold, the LTC3206 will switch to boost mode and automatically soft-start the 1.5x boost charge pump. The constant frequency charge pump is designed to minimize the amount of noise generated at the  $V_{IN}$  supply.



## OPERATION

The 1.5x step-up charge pump uses a patented constant frequency architecture to combine the best efficiency with the maximum available power at the lowest noise level.

The charge pump of the LTC3206 can be forced to come on even if no LEDs are programmed for current. Setting bit A3 in the I<sup>2</sup>C serial port forces the charge pump on (see Figure 3).

### Soft-Start

To prevent excessive inrush current and supply droop when switching into step-up mode, the LTC3206 employs a soft-start feature on its charge pump. The current available to the CPO pin is increased linearly over a period of about 400μs.

### Charge Pump Strength

When the LTC3206 operates in 1.5x boost mode, the charge pump can be modeled as a Thevenin-equivalent circuit to determine the amount of current available from the effective input voltage,  $1.5V_{IN}$  and the effective open-loop output resistance,  $R_{OL}$  (Figure 1).

$R_{OL}$  is dependent on a number of factors including the switching term,  $1/(2f_{OSC} \cdot C_{FLY})$ , internal switch resistances and the non-overlap period of the switching circuit. However, for a given  $R_{OL}$ , the amount of current available will be directly proportional to the advantage voltage  $1.5V_{IN} - V_{CPO}$ . Consider the example of driving white LEDs from a 3.1V supply. If the LED forward voltage is 3.8V and the current sources require 100mV, the advantage voltage is  $3.1V \cdot 1.5 - 3.8V - 0.1V$  or 750mV. Notice that if the input voltage is raised to 3.2V, the advantage voltage jumps to 900mV—a 20% improvement in available strength.

From Figure 1, the available current is given by:

$$I_{OUT} = \frac{1.5V_{IN} - V_{CPO}}{R_{OL}}$$

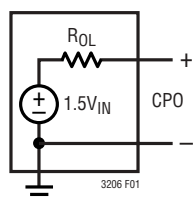

Figure 1. Equivalent Open-Loop Circuit

Typical values of  $R_{OL}$  as a function of temperature are shown in Figure 2.

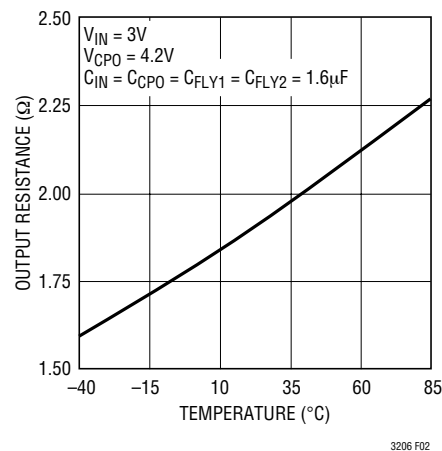

Figure 2. Typical  $R_{OL}$  vs Temperature

### I<sup>2</sup>C Interface

The LTC3206 communicates with a host (master) using the standard I<sup>2</sup>C 2-wire interface. The Timing Diagram (Figure 4) shows the timing relationship of the signals on the bus. The two bus lines, SDA and SCL, must be high when the bus is not in use. External pull-up resistors or current sources, such as the LTC1694 SMBus accelerator, are required on these lines. The LTC3206 is a receive-only (slave) device.

### Bus Speed

The I<sup>2</sup>C port is designed to be operated at speeds of up to 400kHz. It has built-in timing delays to ensure correct operation when addressed from an I<sup>2</sup>C compliant master device. It also contains input filters designed to suppress glitches should the bus become corrupted.

### START and STOP Conditions

A bus-master signals the beginning of a communication to a slave device by transmitting a START condition. A START condition is generated by transitioning SDA from high to low while SCL is high. When the master has finished communicating with the slave, it issues a STOP condition by transitioning SDA from low to high while SCL is high. The bus is then free for communication with another I<sup>2</sup>C device.

## OPERATION

### Byte Format

Each byte sent to the LTC3206 must be 8 bits long followed by an extra clock cycle for the Acknowledge bit to be returned by the LTC3206. The data should be sent to the LTC3206 most significant bit (MSB) first.

### Acknowledge

The Acknowledge bit is used for handshaking between the master and the slave. An Acknowledge (active LOW) generated by the slave (LTC3206) lets the master know that the latest byte of information was received. The Acknowledge related clock pulse is generated by the master. The master releases the SDA line (HIGH) during the Acknowledge clock cycle. The slave-receiver must pull down the SDA line during the Acknowledge clock pulse so that it remains a stable LOW during the HIGH period of this clock pulse.

### Slave Address

The LTC3206 responds to only one 7-bit address which has been factory programmed to 0011011. The eighth bit of the address byte ( $R/\bar{W}$ ) must be 0 for the LTC3206 to recognize the address since it is a write only device. This is equivalent to an 8-bit address where the least significant bit of the address is always 0. If the correct seven bit address is given but the  $R/\bar{W}$  bit is 1, the LTC3206 will not respond.

### Bus Write Operation

The master initiates communication with the LTC3206 with a START condition and a 7-bit address followed by the Write Bit  $R/\bar{W} = 0$ . If the address matches that of the LTC3206, the LTC3206 returns an Acknowledge. The

master should then deliver the most significant data byte. Again the LTC3206 acknowledges and the cycle is repeated two more times for a total of one address byte and three data bytes. Each data byte is transferred to an internal holding latch upon the return of an Acknowledge. After all three data bytes have been transferred to the LTC3206, the master may terminate the communication with a STOP condition. Alternatively, a REPEAT-START condition can be initiated by the master and another chip on the I<sup>2</sup>C bus can be addressed. This cycle can continue indefinitely and the LTC3206 will remember the last input of valid data that it received. Once all chips on the bus have been addressed and sent valid data, a STOP condition can be sent and the LTC3206 will update its command latch with the data that it had received.

In certain circumstances, the data on the I<sup>2</sup>C bus may become corrupted. In these cases the LTC3206 responds appropriately by preserving only the last set of complete data that it has received. For example, assume the LTC3206 has been successfully addressed and is receiving data when a STOP condition mistakenly occurs. The LTC3206 will ignore this stop condition and will not respond until a new START condition, correct address, new set of data and STOP condition are transmitted.

Likewise, if the LTC3206 was previously addressed and sent valid data but not updated with a STOP, it will respond to any STOP that appears on the bus independent of the number of REPEAT-STARTs that have occurred. An exception occurs if a REPEAT-START is given and the LTC3206 successfully acknowledges its addressed. In this case, it will not respond to a STOP after the first data byte is acknowledged. It will, however, respond after the third data byte is acknowledged.



# TIMING DIAGRAM

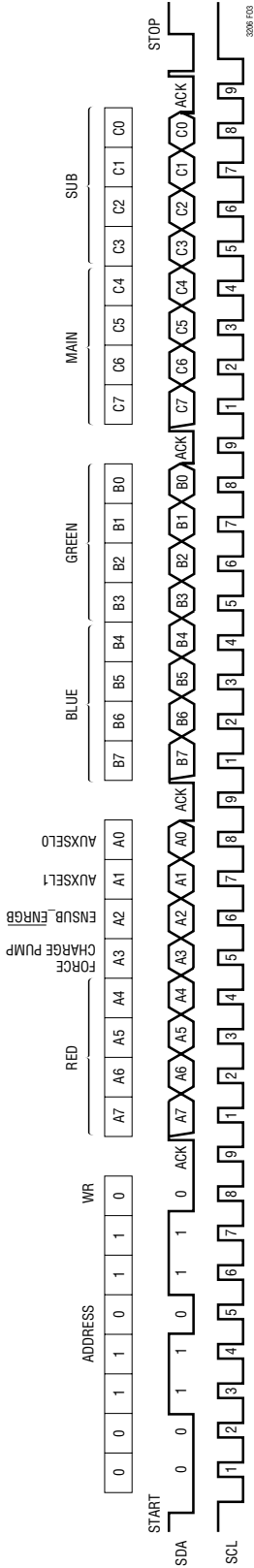

Figure 3. Bit Assignments

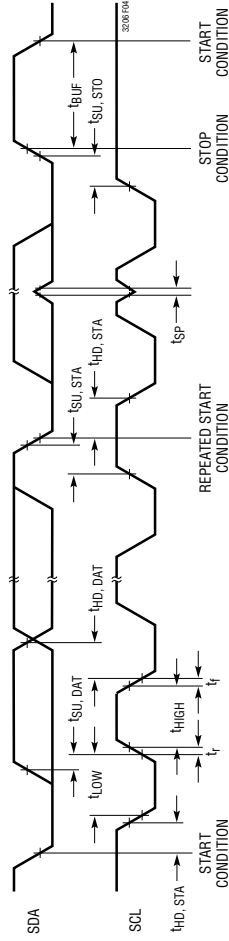

Figure 4. Timing Parameters

Table 1. Serial Port Bit Assignments

RED	A7	A6	A5	A4	MAIN			RED
GREEN	B3	B2	B1	B0	SUB	AUX	GREEN	BRIGHTNESS
BLUE	B7	B6	B5	B4	DUTY CYCLE			LEVEL
MAIN	C7	C6	C5	C4	SUB-RANGE			LEVEL
SUB	C3	C2	C1	C0	SUB-RANGE			BRIGHTNESS
HEX	4-BIT CODE				SUB-RANGE			LEVEL
0	0	0	0	0	NA	NA	OFF	OFF
1	0	0	0	1	1/4	3.13%	0.78%	1/15(6.7%)
2	0	0	1	0	1/4	4.42%	1.07%	2/15(13.3%)
3	0	0	1	1	1/4	6.25%	1.56%	3/15(20.0%)
4	0	1	0	0	1/4	8.80%	2.25%	4/15(26.7%)
5	0	1	0	1	1/4	12.50%	3.13%	5/15(33.3%)
6	0	1	1	0	1/4	17.70%	4.40%	6/15(40.0%)
7	0	1	1	1	1/4	25.00%	6.25%	7/15(46.7%)
8	1	0	0	0	1/4	35.35%	8.90%	8/15(53.3%)
9	1	0	0	1	1/4	50.00%	12.50%	9/15(60.0%)
A	1	0	1	0	1/4	70.70%	17.70%	10/15(66.6%)
B	1	0	1	1	1/4	100.00%	25.00%	11/15(73.3%)
C	1	1	0	0	1/2	70.70%	35.35%	12/15(80.0%)
D	1	1	0	1	1/2	100.00%	50.00%	13/15(86.7%)
E	1	1	1	0	1	70.70%	70.70%	14/15(93.3%)
F	1	1	1	1	1	100.00%	100.00%	15/15(100.0%)

Table 2. Auxiliary LED Pin Assignments

A0	A1	AUX1	AUX2
0	0	MAIN	MAIN
0	1	MAIN	SUB
1	0	SUB	MAIN
1	1	SUB	SUB

Table 3. ENRGB/S Assignment

A2	CONTROL
0	RGB DISPLAY
1	SUB DISPLAY

## APPLICATIONS INFORMATION

### White LED Brightness Control

The White LED displays (MAIN, SUB and AUX) have 16 individual brightness settings. The settings are exponentially spaced to compensate for the nearly logarithmic characteristic of human vision perception. The base of the power settings is  $\sqrt{2}$ . The off setting (0 power) is a special case needed for shutdown.

The LTC3206 uses a subranging technique to control the LED brightness with a combination of both DC level control and pulse width modulation. Table 1 summarizes the level control operation. The DC level of the LEDs will be one of either three sub-range settings, 100%, 50% or 25% of full scale. For example, if the full scale LED current is programmed (via the  $I_{MS}$  pin) to be 20mA, then the “on” level of the LED will be either 20mA, 10mA or 5mA respectively. The power to the LED will be the product of the subrange (DC current) and the PWM setting. For example, if an LED power of 2.25% is desired, then the LTC3206 sets the sub range to 25% and the duty cycle to 8.8%. These settings are designed to optimize the efficiency of the dual-mode LTC3206 power management system while preserving LED color accuracy at low power levels.

To achieve brightness control by purely DC means, only the 100%, 50% or 25% power settings should be selected.

The DC current levels of the MAIN, SUB and AUX LEDs are controlled by a precisely mirrored multiple of the current at the  $I_{MS}$  pin. The  $I_{MS}$  pin servos to a fixed level of 0.6V so the current is programmed simply by adding a resistor from  $I_{MS}$  to ground.

The current that flows during the “on” time will follow the relationship:

$$I_{LED} = 400 \cdot S \cdot \frac{0.6V}{R_{MS}}$$

where S is the subrange for the given power setting (it will be either 25%, 50% or 100%, see Table 1) and  $R_{MS}$  is the value of the resistor at the  $I_{MS}$  pin.

The average LED current (LED power level) will follow the relationship:

$$AVG(I_{LED}) = 400 \cdot \frac{0.6V}{R_{MS}} \cdot \sqrt{2}^{D-15}$$

where D is the decimal equivalent of the 4-bit digital code programmed for the given display (0 to 15).

The PWM frequency is 1/1024 of the frequency of the charge pump oscillator (typically 938Hz). During PWM, the LED currents are soft-switched to minimize noise.

### AUX LEDs

The AUX1 and AUX2 LEDs can be arbitrarily assigned to either the MAIN or SUB display. Table 2 summarizes the assignment possibilities. When an AUX pin is assigned to a display, it will follow the power level (both DC and PWM) set for that display.

### Unused White LED Pins

The LTC3206 can power up to eight white LEDs (four for the MAIN display, two for the SUB display and the two flexible AUX pins), however, it is not necessary to use all eight in each application.

Any of these LED pins can cause the LTC3206 to switch from 1x mode to 1.5x charge pump mode if they drop out. In fact, if an unused LED pin is left unconnected or grounded, it *will* drop out and force the LTC3206 into charge pump mode.

To avoid this problem, unused MAIN, SUB or AUX LED pins can be disabled by connecting them to CPO. Power is not wasted in this configuration. When the LED pin voltage is within approximately 1V of CPO, its LED current is switched off and only a small 10 $\mu$ A test current remains. Figure 5 shows a block diagram of each of the MAIN, SUB and AUX LED pins.

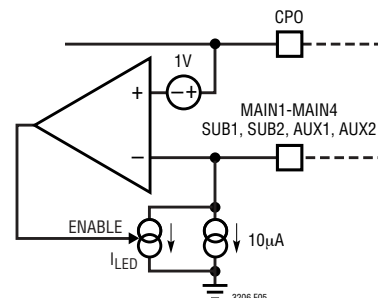

Figure 5. Internal MAIN, SUB and AUX LED Disable Circuit

## APPLICATIONS INFORMATION

The RED, GREEN and BLUE pins can also enable the charge pump, however, since they each have individual disable control they can be left floating or grounded if unused.

### RGB Illuminator Brightness Control

The RED, GREEN and BLUE LEDs can be individually set to have a linear duty cycle ranging from 0/15 (off) to 15/15 (full on) with 1/15 increments in between. The combination of 16 possible brightness levels gives the RGB indicator LED a total of 4096 colors. Table 1 indicates the decoding of the RED, GREEN and BLUE LEDs.

The full-scale currents in the RED, GREEN and BLUE LEDs are controlled by the current at the  $I_{RGB}$  pin in a similar manner to those in the MAIN, SUB and AUX LEDs. The  $I_{RGB}$  pin also servos to 0.6V and the RGB LED currents are a precise multiple of the  $I_{RGB}$  current. The DC value of the RGB display LED currents will follow the relationship:

$$I_{RED, GREEN, BLUE} = 400 \frac{0.6V}{R_{RGB}}$$

where  $R_{RGB}$  is the value of the resistor at the  $I_{RGB}$  pin.

The average value of the current in the RED, GREEN and BLUE LEDs will be:

$$AVG(I_{RED, GREEN, BLUE}) = 400 \cdot \frac{D}{15} \cdot \frac{0.6V}{R_{RGB}}$$

where D is the decimal equivalent of the 4-bit digital code programmed for the given LED (0 to 15). Table 1 summarizes the RED, GREEN and BLUE LED power settings.

The RED, GREEN and BLUE LEDs are pulse width modulated at a frequency of 1/240 of the frequency of the charge pump oscillator or about 4kHz.

### ENRGB/S Pin

The ENRGB/S pin can be used to enable or disable the LTC3206 without re-accessing the I<sup>2</sup>C port. This might be useful to indicate an incoming phone call without waking the microcontroller. ENRGB/S can be software programmed as an independent control for either the RGB display or the SUB display. Control bit A2 in the serial port

(see Figure 3 and Table 3) determines which display ENRGB/S controls. When bit A2 is 0, the ENRGB/S pin controls the RGB display. If it is set to 1, ENRGB/S controls the SUB display.

To use the ENRGB/S pin, the I<sup>2</sup>C port must first be configured to the desired setting. For example, if ENRGB/S will be used to control the SUB display, then a non-zero code must reside in the C3-C0 nibble of the I<sup>2</sup>C port and bit A2 must be set to 1 (see Table 1). Now when ENRGB/S is high ( $DV_{CC}$ ), the SUB display will be on with the C3-C0 setting. When ENRGB/S is low, the SUB display will be off. If no other displays are programmed to be on, the entire chip will be in shutdown.

Likewise, if ENRGB/S will be used to enable the RGB display, then a non-zero code must reside in one of the RED, GREEN or BLUE nibbles of the serial port (A4-A7 or B0-B7), and bit A2 must be 0. Now when ENRGB/S is high ( $DV_{CC}$ ), the RGB display will light with the programmed color. When ENRGB/S is low, the RGB display will be off. If no other displays are programmed to be on, the entire chip will be in shutdown.

If bit A2 is set to 1 (SUB display control), then ENRGB/S will have no effect on the RGB display. Likewise, if bit A2 is set to 0 (RGB display control), then ENRGB/S will have no effect on the SUB display.

If the ENRGB/S pin is not used, it should be connected to  $DV_{CC}$ . It should not be grounded or left floating.

### $V_{IN}$ , CPO Capacitor Selection

The style and value of capacitors used with the LTC3206 determine several important parameters such as regulator control-loop stability, output ripple and charge pump strength. To reduce noise and ripple, it is recommended that low equivalent series resistance (ESR) multilayer ceramic capacitors be used on both  $V_{IN}$  and CPO. Tantalum and aluminum capacitors are not recommended because of their high ESR. The value of the capacitor on CPO directly controls the amount of output ripple for a given load current. Increasing the size of this capacitor will reduce the output ripple. The peak-to-peak output ripple is approximately given by the expression:

$$V_{RIPPLE-P} \approx \frac{I_{CPO}}{3f_{OSC} \cdot C_{CPO}}$$

## APPLICATIONS INFORMATION

where  $f_{OSC}$  is the LTC3206's oscillator frequency (typically 960kHz) and  $C_{CPO}$  is the output charge storage capacitor on CPO. Both the style and value of the output capacitor can significantly affect the stability of the LTC3206. The LTC3206 uses a linear control loop to adjust the strength of the charge pump to match the current required at the output. The error signal of this loop is stored directly on the output charge storage capacitor. The charge storage capacitor also serves to form the dominant pole for the control loop. To prevent ringing or instability, it is important for the output capacitor to maintain at least  $0.6\mu\text{F}$  of capacitance over all conditions. Likewise, excessive ESR on the output capacitor will tend to degrade the loop stability of the LTC3206. The closed-loop output resistance of the LTC3206 is designed to be  $0.4\Omega$ . For a 100mA load current change, the error signal will change by about 40mV. If the output capacitor has  $0.4\Omega$  or more of ESR, the closed-loop frequency response will cease to roll off in a simple one-pole fashion and poor load transient response or instability could result. Multilayer ceramic chip capacitors typically have exceptional ESR performance. MLCC capacitors combined with a tight board layout, will yield very good stability. As the value of  $C_{CPO}$  controls the amount of output ripple, the value of  $C_{IN}$  controls the amount of ripple present at the input pin ( $V_{IN}$ ). The input current to the LTC3206 will be relatively constant while the charge pump is on either the input charging phase or the output charging phase but will drop to zero during the clock nonoverlap times. Since the non-overlap time is small ( $\sim 25\text{ns}$ ), these missing "notches" will result in only a small perturbation on the input power supply line. Note that a higher ESR capacitor such as tantalum will have higher input noise due to the input current change times the ESR. Therefore, ceramic capacitors are again recommended for their exceptional ESR performance. Input noise can be further reduced by powering the LTC3206 through a very small series inductor as shown in Figure 6. A 10nH inductor will reject the fast current notches, thereby presenting a nearly constant current load to the input power supply. For economy, the 10nH inductor can be fabricated on the PC board with about 1cm (0.4") of PC board trace.

### Flying Capacitor Selection

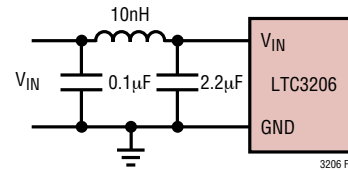

**Figure 6. 10nH Inductor Used for Input Noise Reduction (Approximately 1cm of Wire)**

*Warning: A polarized capacitor such as tantalum or aluminum should never be used for the flying capacitors since their voltage can reverse upon start-up of the LTC3206. Ceramic capacitors should always be used for the flying capacitors.*

The flying capacitor controls the strength of the charge pump. In order to achieve the rated output current it is necessary to have at least  $1\mu\text{F}$  of capacitance for each of the flying capacitors. Capacitors of different materials lose their capacitance with higher temperature and voltage at different rates. For example, a ceramic capacitor made of X7R material will retain most of its capacitance from  $-40^{\circ}\text{C}$  to  $85^{\circ}\text{C}$  whereas a Z5U or Y5V style capacitor will lose considerable capacitance over that range. Z5U and Y5V capacitors may also have a very poor voltage coefficient causing them to lose 60% or more of their capacitance when the rated voltage is applied. Therefore, when comparing different capacitors, it is often more appropriate to compare the amount of achievable capacitance for a given case size rather than comparing the specified capacitance value. For example, over rated voltage and temperature conditions, a  $1\mu\text{F}$ , 10V, Y5V ceramic capacitor in a 0603 case may not provide any more capacitance than a  $0.22\mu\text{F}$ , 10V, X7R available in the same 0603 case. The capacitor manufacturer's data sheet should be consulted to determine what value of capacitor is needed to ensure minimum capacitances at all temperatures and voltages.

## APPLICATIONS INFORMATION

Table 4 shows a list of ceramic capacitor manufacturers and how to contact them:

**Table 4. Recommended Capacitor Vendors**

AVX	www.avxcorp.com
Kemet	www.kemet.com
Murata	www.murata.com
Taiyo Yuden	www.t-yuden.com
Vishay	www.vishay.com

For very light load applications, the flying capacitors may be reduced to save space or cost. The theoretical minimum output resistance of a 1.5x fractional charge pump is given by:

$$R_{OL(MIN)} = \frac{1.5V_{IN} - V_{OUT}}{I_{OUT}} = \frac{1}{2f_{OSC}C_{FLY}}$$

where  $f_{OSC}$  is the switching frequency (960kHz typ) and  $C_{FLY}$  is the value of the flying capacitors. Note that the charge pump will typically be weaker than the theoretical limit due to additional switch resistance, however for very light load applications, the above expression can be used as a guideline in determining a starting capacitor value.

### Layout Considerations and Noise

Due to its high switching frequency and the transient currents produced by the LTC3206, careful board layout is necessary. A true ground plane and short connections to all capacitors will improve performance and ensure proper regulation under all conditions. Figure 7 shows the recommended layout configuration.

The flying capacitor pins C1+, C2+, C1- and C2- will have very high edge rate waveforms. The large dv/dt on these pins can couple energy capacitively to adjacent printed circuit board runs. Magnetic fields can also be generated if the flying capacitors are not close to the LTC3206 (i.e., the loop area is large). To decouple capacitive energy transfer, a Faraday shield may be used. This is a grounded PC trace between the sensitive node and the LTC3206 pins. For a high quality AC ground, it should be returned to a solid ground plane that extends all the way to the LTC3206.

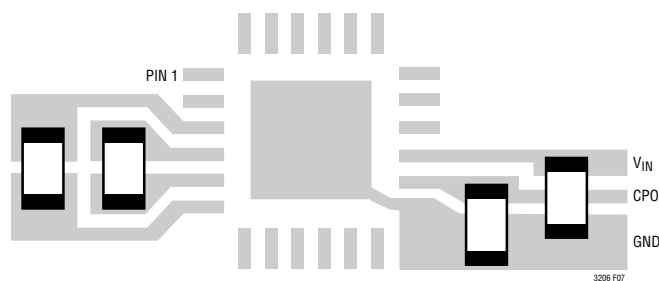

**Figure 7. Optimum Single Layer PCB Layout**

### Power Efficiency

To calculate the power efficiency ( $\eta$ ) of a white LED driver chip, the LED power should be compared to the input power. The difference between these two numbers represents lost power whether it is in the charge pump or the current sources. Stated mathematically, the power efficiency is given by:

$$\eta = \frac{P_{LED}}{P_{IN}}$$

The efficiency of the LTC3206 depends upon the mode in which it is operating. Recall that the LTC3206 operates as a pass switch, connecting  $V_{IN}$  to CPO until one of the LEDs drops out. This feature provides the optimum efficiency available for a given input voltage and LED forward voltage. When it is operating as a switch, the efficiency is approximated by:

$$\eta = \frac{P_{LED}}{P_{IN}} = \frac{V_{LED} \cdot I_{LED}}{V_{IN} \cdot I_{IN}} \approx \frac{V_{LED}}{V_{IN}}$$

since the input current will be very close to the LED current.

At moderate to high output power, the quiescent current of the LTC3206 is negligible and the expression above is valid. For example, with  $V_{IN} = 3.9V$ ,  $I_{OUT} = 20mA \cdot 6$  LEDs and  $V_{LED}$  equal to 3.6V, the measured efficiency is 92.2%, which is very close to the theoretical 92.3% calculation.



## APPLICATIONS INFORMATION

Once an LED pin drops out, the LTC3206 switches into step-up mode. Employing the fractional ratio 1.5x charge pump, the LTC3206 provides more efficiency than would be achieved with a voltage doubling charge pump.

In 1.5x boost mode, the efficiency is similar to that of a linear regulator with an effective input voltage of 1.5 times the actual input voltage. This is because the input current for a 1.5x fractional charge pump is approximately 1.5 times the load current. In an ideal 1.5x charge pump, the power efficiency would be given by:

$$\eta_{IDEAL} = \frac{P_{LED}}{P_{IN}} = \frac{V_{LED} \cdot I_{LED}}{V_{IN} \cdot 1.5I_{LED}} \cong \frac{V_{LED}}{1.5V_{IN}}$$

### Thermal Management

For higher input voltages and maximum output current, there can be substantial power dissipation in the LTC3206. If the junction temperature increases above approximately 160°C the thermal shutdown circuitry will automatically deactivate the output. To reduce the maximum junction temperature, a good thermal connection to the PC board is recommended. Connecting the PGND pin (exposed center pad) to a ground plane and maintaining a solid ground plane under the device can reduce the thermal resistance of the package and PC board considerably.

### Brightness Control

Although the LTC3206 has many exponentially spaced brightness settings for the main and sub displays, it is possible to control the brightness by alternative means. Figure 8 shows an example of how an external voltage source can be used to inject a current into the  $I_{MS}$  or  $I_{RGB}$  pins to control brightness. For example, if R1 and R2 are 24k, then the LED current would range from 20mA to 0mA as  $V_{CNTRL}$  is swept from 0V to 1.2V.

Alternatively, if only digital outputs are available, the number of settings can be doubled from 15 to 30 by simply

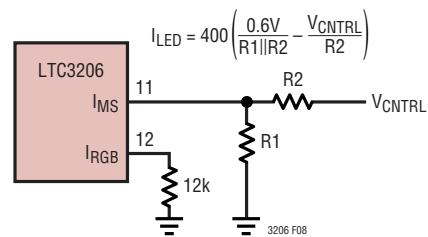

Figure 8. Alternative Linear Brightness Control

connecting  $V_{CNTRL}$  to a digital signal. This topology can be extended to any number of bits and can also be applied to the RGB display.

Finally, PWM brightness control can be achieved by apply-

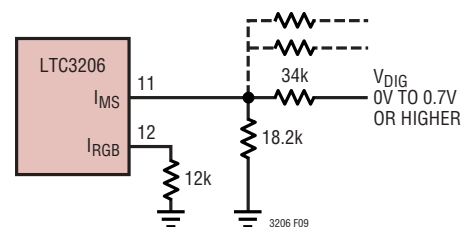

Figure 9. Alternative Digital Brightness Control

ing a PWM signal to the  $I_{MS}$  programming resistor as shown in Figure 10. The signal should range from 0V (full on) to any voltage above 0.7V (full off).

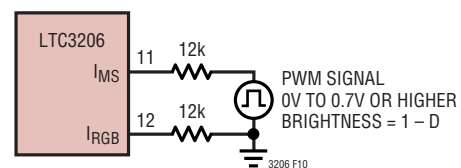
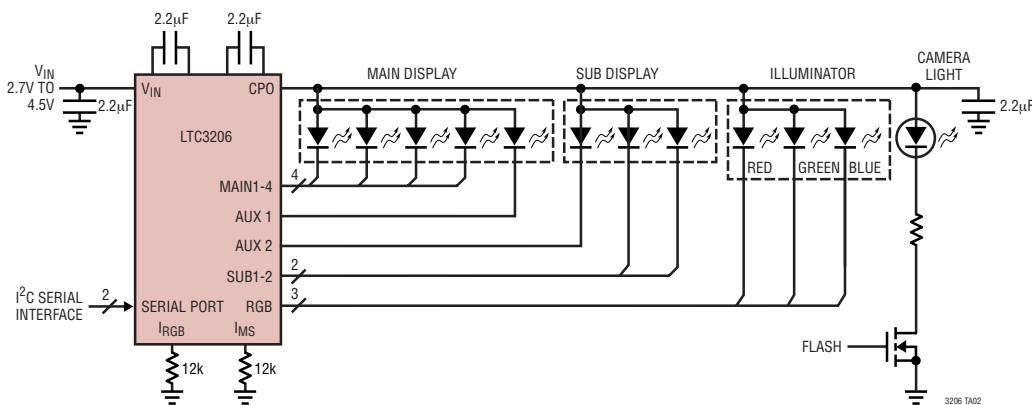

Figure 10. PWM Brightness Control of the MAIN and SUB Displays



# TYPICAL APPLICATIONS

## 4-Display Controller



## Main Backlight, Keypad Backlight Plus Motor Controller

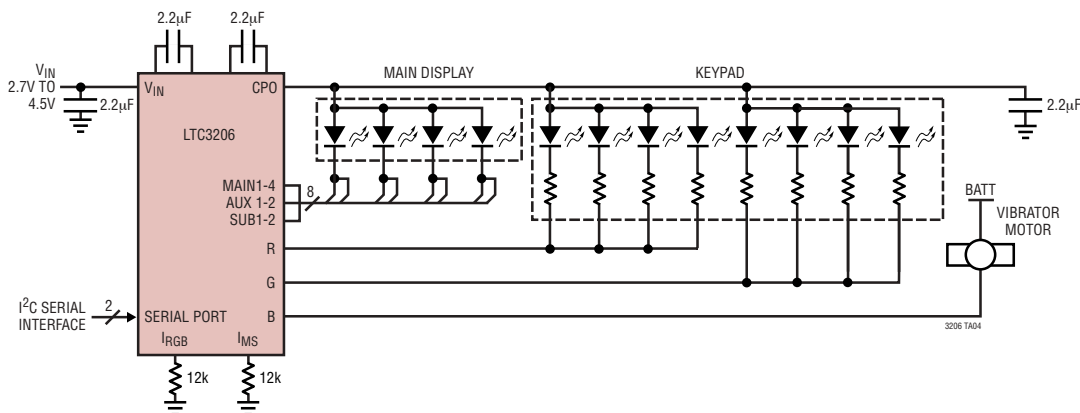

# PACKAGE DESCRIPTION

## UF Package 24-Lead Plastic QFN (4mm × 4mm) (Reference LTC DWG # 05-08-1692)

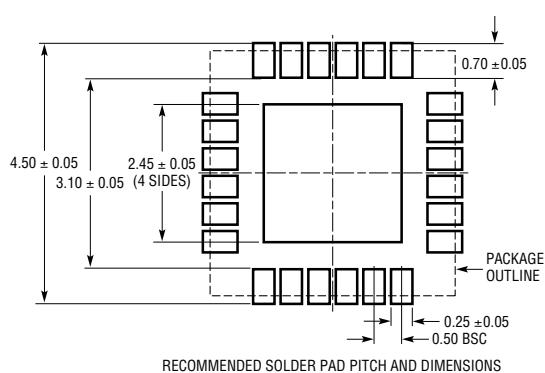

RECOMMENDED SOLDER PAD PITCH AND DIMENSIONS

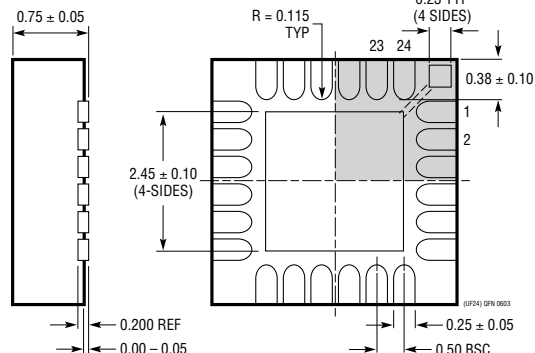
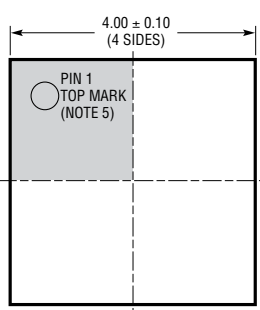

- NOTE:
1. DRAWING PROPOSED TO BE MADE A JEDEC PACKAGE OUTLINE MO-220 VARIATION (WGGD-X)—TO BE APPROVED
  2. ALL DIMENSIONS ARE IN MILLIMETERS
  3. DIMENSIONS OF EXPOSED PAD ON BOTTOM OF PACKAGE DO NOT INCLUDE MOLD FLASH. MOLD FLASH, IF PRESENT, SHALL NOT EXCEED 0.15mm ON ANY SIDE, IF PRESENT
  4. EXPOSED PAD SHALL BE SOLDER PLATED
  5. SHADED AREA IS ONLY A REFERENCE FOR PIN 1 LOCATION ON THE TOP AND BOTTOM OF PACKAGE
  6. DRAWING NOT TO SCALE

## TYPICAL APPLICATION

### 5-LED Main Plus Low/High Current Camera Light

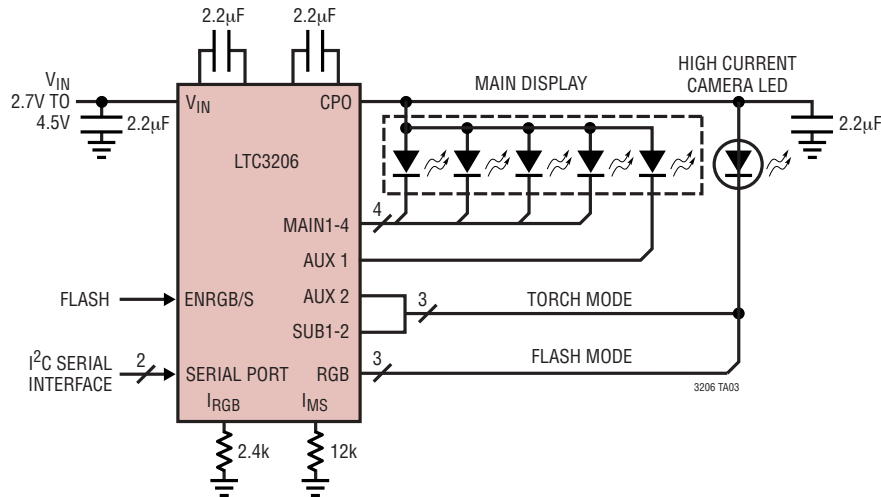

## RELATED PARTS

PART NUMBER	DESCRIPTION	COMMENTS
LT <sup>®</sup> 1618	Constant Current, Constant Voltage, 1.4MHz High Efficiency Boost Regulator	Up to 16 White LEDs, $V_{IN}$ : 1.6V to 18V, $V_{OUT(MAX)}$ = 34V, $I_Q$ = 1.8mA, $I_{SD} \leq 1\mu A$ , 10-Lead MS Package
LTC1911-1.5	250mA ( $I_{OUT}$ ), 1.5MHz High Efficiency Step-Down Charge Pump	75% Efficiency, $V_{IN}$ : 2.7V to 5.5V, $V_{OUT(MIN)}$ = 1.5V/1.8V, $I_Q$ = 180 $\mu A$ , $I_{SD} \leq 10\mu A$ , MS8 Package
LT1932	Constant Current, 1.2MHz High Efficiency White LED Boost Regulator	Up to 8 White LEDs, $V_{IN}$ : 1V to 10V, $V_{OUT(MAX)}$ = 34V, $I_Q$ = 1.2mA, $I_S \leq 1\mu A$ , ThinSOT <sup>™</sup> Package
LT1937	Constant Current, 1.2MHz High Efficiency White LED Boost Regulator	Up to 4 White LEDs, $V_{IN}$ : 2.5V to 10V, $V_{OUT(MAX)}$ = 34V, $I_Q$ = 1.9mA, $I_{SD} \leq 1\mu A$ , ThinSOT, SC70 Packages
LTC3200-5	Low Noise, 2MHz Regulated Charge Pump White LED Driver	Up to 6 White LEDs, $V_{IN}$ : 2.7V to 4.5V, $V_{OUT(MAX)}$ = 5V, $I_Q$ = 8mA, $I_{SD} \leq 1\mu A$ , ThinSOT Package
LTC3201	Low Noise, 1.7MHz Regulated Charge Pump White LED Driver	Up to 6 White LEDs, $V_{IN}$ : 2.7V to 4.5V, $V_{OUT(MAX)}$ = 5V, $I_Q$ = 6.5mA, $I_{SD} \leq 1\mu A$ , 10-Lead MS
LTC3202	Low Noise, 1.5MHz Regulated Charge Pump White LED Driver	Up to 8 White LEDs, $V_{IN}$ : 2.7V to 4.5V, $V_{OUT(MAX)}$ = 5V, $I_Q$ = 5mA, $I_{SD} \leq 1\mu A$ , 10-Lead MS Package
LTC3205	Multi-Display LED Controller	92% Efficiency, $V_{IN}$ : 2.8V to 4.5V, $I_Q$ = 50 $\mu A$ , $I_{SD} \leq 1\mu A$ , 4mm x 4mm QFN Package
LTC3251	500mA ( $I_{OUT}$ ), 1MHz to 1.6MHz Spread Spectrum Step-Down Charge Pump	85% Efficiency, $V_{IN}$ : 3.1V to 5.5V, $V_{OUT}$ : 0.9V to 1.6V, $I_Q$ = 9 $\mu A$ , $I_{SD} \leq 1\mu A$ , 10-Lead MS Package
LTC3405/LTC3405A	300mA ( $I_{OUT}$ ), 1.5MHz Synchronous Step-Down DC/DC Converter	95% Efficiency, $V_{IN}$ : 2.7V to 6V, $V_{OUT(MIN)}$ = 0.8V, $I_Q$ = 20 $\mu A$ , $I_{SD} \leq 1\mu A$ , ThinSOT Package
LTC3406/LTC3406B	600mA ( $I_{OUT}$ ), 1.5MHz Synchronous Step-Down DC/DC Converter	95% Efficiency, $V_{IN}$ : 2.5V to 5.5V, $V_{OUT(MIN)}$ = 0.6V, $I_Q$ = 20 $\mu A$ , $I_{SD} \leq 1\mu A$ , ThinSOT Package
LTC3440	600mA ( $I_{OUT}$ ), 2MHz Synchronous Buck-Boost DC/DC Converter	95% Efficiency, $V_{IN}$ : 2.5V to 5.5V, $V_{OUT(MIN)}$ = 2.5V, $I_Q$ = 25 $\mu A$ , $I_{SD} \leq 1\mu A$ , 10-Lead MS Package
LT3465/LT3465A	1.2MHz/2.7MHz with Internal Schottky	Up to 6 White LEDs, $V_{IN}$ : 12.7V to 16V, $V_{OUT(MAX)}$ = 34V, $I_Q$ = 1.9mA, $I_{SD} < 1\mu A$ , ThinSOT Package

ThinSOT is a trademark of Linear Technology Corporation.